



# forma-stor coshh™

Product code: FR100-C

- » Quick-assembly modular storage for hazardous substances.
- » Heavy-duty open steel floor, allowing spillages to drain into the sump.
- » This unit arrives flat packed or assembled at additional cost.



## Product features



2x 5-lever deadlock



Forklift pockets



Crane lifting eyes



COSHH compliant



Sump capacity



Collapsible



Stackable



Fire resistant

## Product specifications

Weight	277kg
Colour	Traffic red: RAL 3020
Suitable for	Outdoor storage of flammables or chemicals
Finished coating	Galvanised and powder coated
Material & thickness	1mm and 2mm steel
Quantity of keys	3 keys
How are castors fitted?	Not applicable
Other sizes available	3 other sizes
Ventilation	Yes
Qty of shelves as standard	0 shelves

## Dimensions - External dimensions includes protrusions

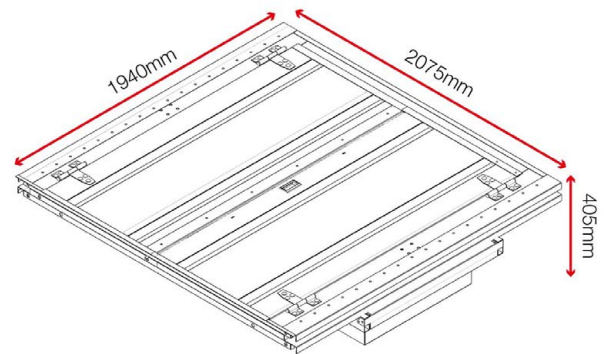

## Optional extras - Contact Armorgard to find out more



Shelf FRS2



BlokkaBar FRBL2

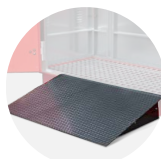

Ramp FRR4

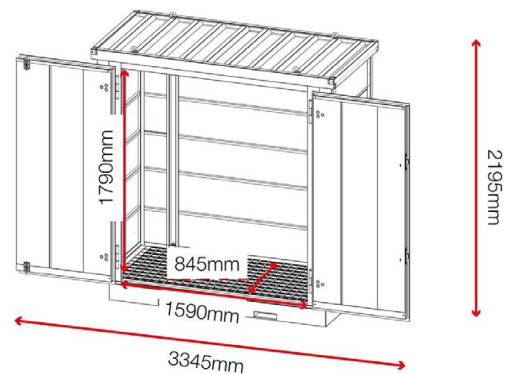

Disclaimer: all dimensions and weights are approximate