



Barcode: 5060452081984

# forma-stor™

Product code: FR200-T

- » A quick-assembly, modular solution for secure storage.
- » This unit arrives flat packed or assembled at additional cost.
- » Its range of accessories makes it versatile for any use.



Watch the Forma-Stor in action



## Product features



2x 5-lever deadlock



Forklift pockets



Crane lifting eyes



Collapsible



Stackable



Up to 5 shelves



Suitable for site



CE marking

## Product specifications

Weight	380kg
Colour	Black grey: RAL 7021
Suitable for	Site
Finished coating	Galvanised and powder coated
Material & thickness	1mm and 2mm steel
Quantity of keys	3 keys
Suitable for vehicle mounting	No
How are castors fitted?	Not applicable
Other sizes available	3 other sizes
Qty of shelves as standard	No

## Dimensions

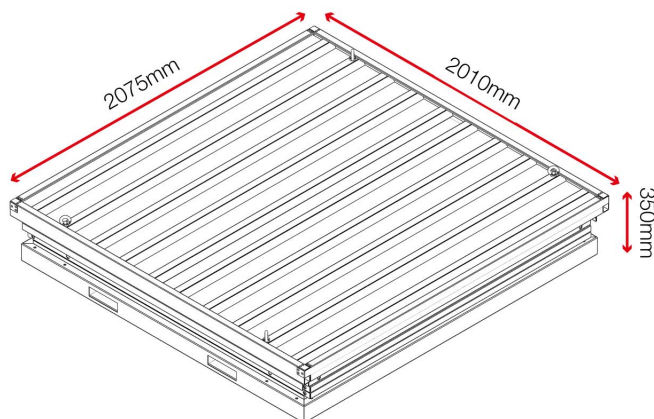

## Optional extras - Contact Armorgard to find out more



Shelf FRS2



BlokkaBar FRBL2

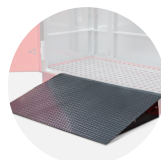

Ramp FRR4



Lighting Kit FRLK-110

